



**Table of Contents**

Table of Contents ..... Page 1  
 Approvals ..... Page 1  
 Attention ..... Page 1  
 Specification ..... Page 2  
 Mounting ..... Page 3  
 Wiring ..... Page 3  
 VDK Wiring with and without cm module .... Page 4  
 Operation ..... Page 5  
 Adjustments & Leak Detection Limits ..... Page 6  
 Maintenance & Testing ..... Page 7  
 Trouble Shooting ..... Page 7  
 Accessories & Replacement ..... Page 7



**Approvals**

 **UL Recognized**  
File # MH 17004

 **CSA Certified**  
File # 1637485

 **FM Approved**  
File # J.I. 0T2A4.AF

New York City: File # MEA 51-05-E

Commonwealth of Massachusetts Approved Product Approval code G1-1107-35

**Attention**



The installation and maintenance of this product must be done under the supervision of an experienced and trained specialist. Never perform work if gas pressure or power is applied, or in the presence of an open flame.



Check the ratings in the specifications to verify that they are suitable for your application.



Please read the instruction before installing or operating. Keep the instruction in a safe place. You find the instruction also at [www.dungs.com](http://www.dungs.com) If these instructions are not heeded, the result may be personal injury or damage to property.



On completion of work on the valve proving system, perform a external leakage and function test.



Any adjustment and application-specific adjustment values must be made in accordance with the equipment manufacturers instructions.



This product is intended for installations covered by, but not limited to, the following codes and standards: NFPA 86, NFPA 85, XL GAP (formerly IRI) or CSA B149.3.

**Explanation of symbols**

- 1, 2, 3 ... = Action
- = Instruction

# Specification

**VDK** The VDK A S06 and S02 valve proving system checks that both safety shutoff valves in a gas train are closed before either a system start-up or after shutdown when wired and interlocked with a suitable flame safeguard. The VDK will halt the start-up sequence to a burner if it detects an open valve or damaged safety shutoff valve seat, thus preventing ignition under potentially dangerous conditions.

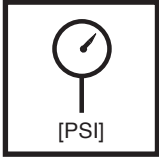

**Max. Operating Pressure (MOP)**  
5 PSI (360 mbar)  
**Max. Body Pressure**  
15 PSI (1000 mbar)

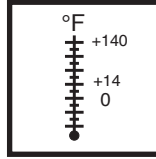

**Ambient / Fluid Temperature**  
+14 °F to +140 °F  
(-10 °C to +60 °C)  
**Storage**  
-40 °F to +180 °F  
(-40 °C to +82 °C)



**Electrical Ratings**  
110 - 120 VAC / 60 Hz;  
**Power Consumption**  
During valve proving period 80 VA  
Standby / In operation after valve proving 20 VA  
**Switch Output Ratings**  
Run: 4 A res, 2 A FLA @ 120 VAC 60 Hz  
Alarm: 1 A res, 0.5 A FLA @ 120 VAC 60 Hz

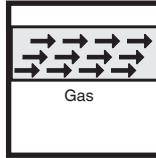

**Gases**  
Dry, natural gas, propane, air and other inert gases. (Not Hydrogen)  
A "dry" gas has a dew point lower than +15 °F and its relative humidity is less than 60 %.  
**Materials in Contact with Gas**  
Housing: Aluminum  
Seals: NBR-based rubber  
**Detection Limits of Natural Gas (each valve)**  
0.3 - 1.76 ft<sup>3</sup>/h (0.2 - 1.0 ft<sup>3</sup>/h leakage through both valves)

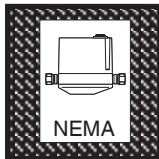

**Enclosure Rating**  
NEMA Type 12

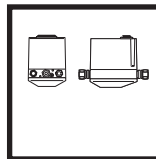

**Operating Time**  
100 % duty cycle; Maximum 15 test cycles per hour  
**Release Period (time to get a RUN or ALARM)**  
ALARM = 32 s ± 3 s  
RUN = 26 s maximum

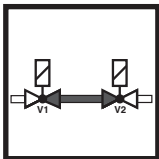

**Max. Test Volume between Safety Shutoff Valves**  
0.7 ft<sup>3</sup>

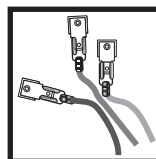

**Electrical Connections**  
Screw terminals with 1/2" NPT conduit connection  
Optional model with Brad Harrison™ connector (46021-1)

## Mounting

### Support & Protection

- This device is not intended to support any weight. Do not use the VDK 200 to support adjacent piping. A metal support structure should be used, dependent on the environment where the VDK 200 will be placed. The structure should provide adequate support and eliminate vibration.

### Recommended Mounting Procedure

1. Schedule 40 piping or steel tubing only.
2. Verify that the internal pipe surfaces are clean and free of debris. Clean if necessary.
3. Mount the inlet connection of the VDK 200 connecting pipe to the upstream side of valve 1; mount the outlet side of the VDK 200 to the upstream side of valve 2.
4. DO NOT exceed 400 lb-in of torque on VDK 200 pipe connections.
5. DO NOT use the VDK 200 as a lever.
6. Perform a complete leak test to verify that no leakage occurs at any gas connection between the VDK 200 and the automatic shutoff valves.

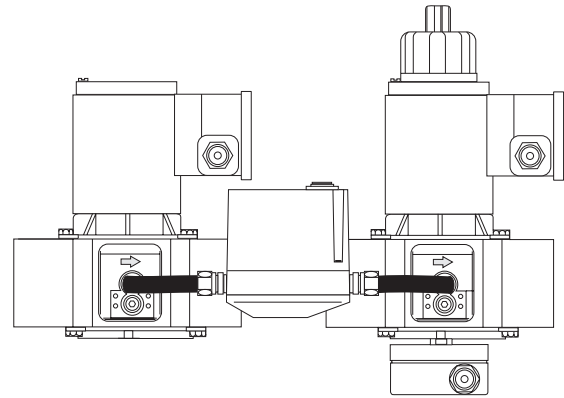

**!** The gas piping between VDK and the safety shutoff valves must be used to provide mechanical support only for the VDK, and the gas piping must be protected from corrosive chemicals or thermal stresses that exceed the ratings of the pipe or that of the VDK.

## Wiring

### Wiring Procedure

1. Use 14 or 16 gauge wire rated for 95°C(200°F).
2. Disconnect all power to the VDK 200 before beginning the wiring to prevent electrical shock and equipment damage.
3. Remove the cover of the VDK 200 by loosening the three screws on the sides of the VDK 200.
4. Attach 1/2" NPT conduit to the black conduit adapter.
5. Install a conduit plug at some point in the conduit run between the VDK and closest panel that contains switching contacts or other sparking devices (see NFPA 86 requirements about potential risks of gas leaking down conduit).
6. Route the wires through the conduit connector.
7. Connect the wiring to the appropriate screw terminals on the terminal strip. Replace the cover, and secure the screws. Typical wiring diagrams for operating the VDK 200 are shown on the next page.

**!** Frequency converters or frequency drive motors with insufficient shielding can cause faults in the VDK 200 as the result of transients. Verify that the equipment is provided with sufficient shielding.

**!** Do not wire the VDK RUN terminal to directly power the safety shutoff valves. The safety shutoff valves should always be under direct command of the flame safeguard.

### Wiring of VDK 200A S06

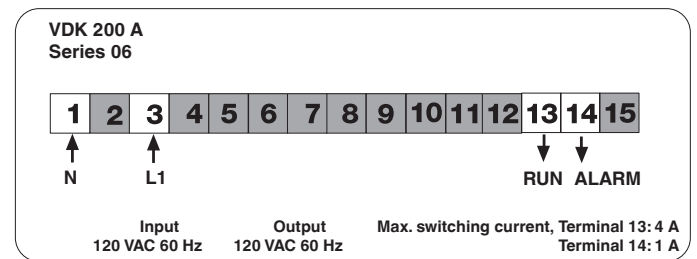

### Wiring of VDK 200A S02

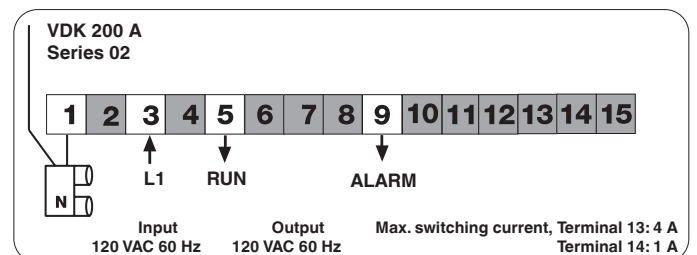

**!** All wiring must comply with local electrical codes, ordinances and regulations.

**!** Operating voltage 120 VAC / 60 Hz

**!** Only use the designated terminals. Otherwise injury or damage will occur.

# VDK Wiring with and without cm module

## VDK wired as proof of closure to prove safety shutoff valves on a startup

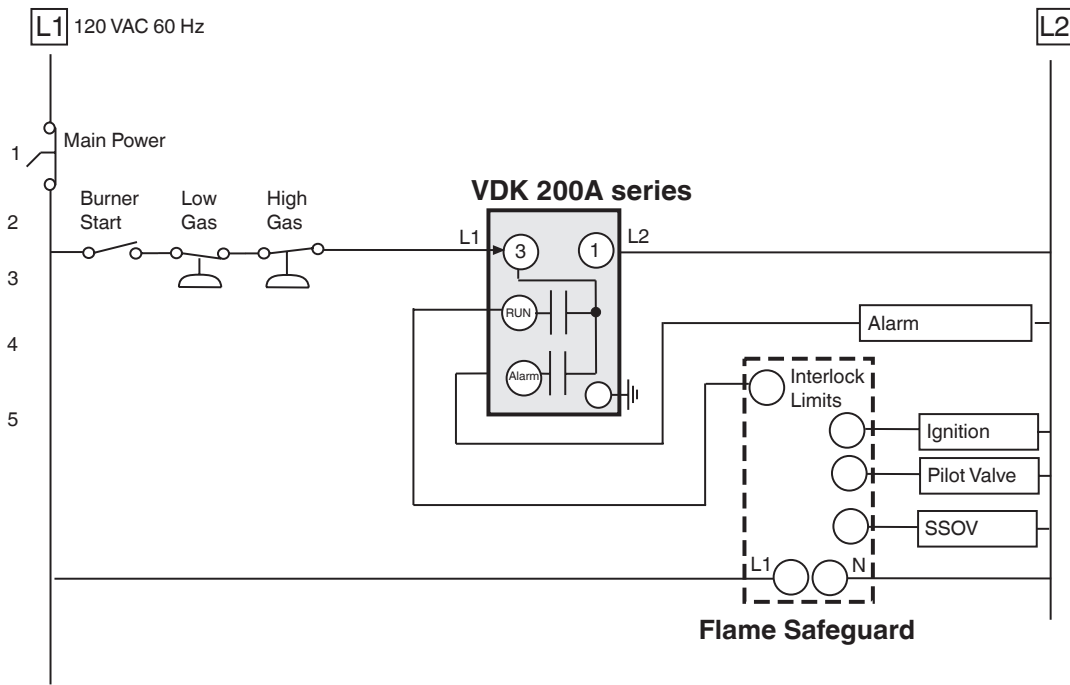

# Operation

## Functional principle

The VDK 200 proves the integrity and the effective closure of the automatic shutoff valve seats by pumping gas from upstream of the main automatic shutoff valve to the volume between the two automatic shutoff valves and detecting leakage. The VDK 200 proves the valves as soon as power is applied.

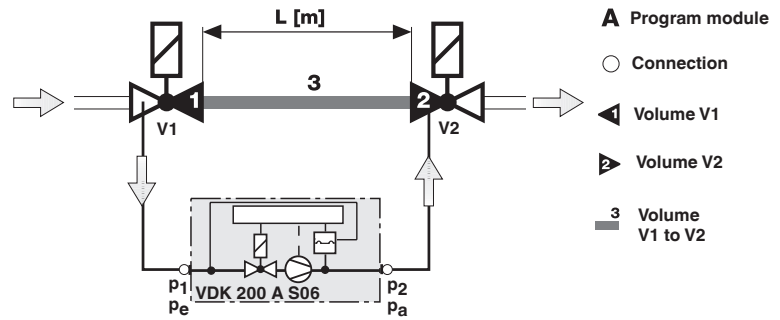

## Program sequence

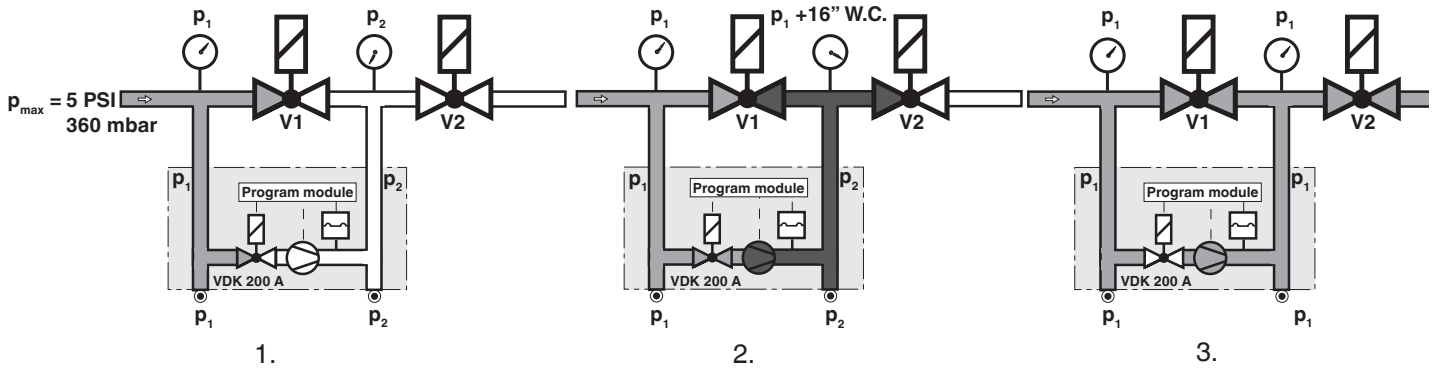

**1. Idle state:** Valves 1 and 2 are closed.

**2. Valve proving:** The internal pump pumps gas pressure from upstream the first automatic shutoff valve,  $p_1$ , to the volume between the two automatic shutoff valves. The gas pressure between the two automatic shutoff valves,  $p_2$ , increases approx. 16 in. W.C. above  $p_1$ . During valve proving, the internal differential pressure switch monitors the pressure between the two automatic shutoff valves. If  $p_2$  increases approx. 16 in. W.C. above  $p_1$ , the motor pump is switched off (end of valve proving) and the contact "RUN" is energized after the release period is complete (26 s max). The yellow signal lamp glows continuously.

If  $p_2$  does not increase approx. 16 in. W.C. above  $p_1$ , the motor pump is switched off (end of valve proving) and the contact "ALARM" is energized after the release period is complete (32 +/-3 s max). The red signal lamp glows continuously.

### ALARM

1. Switch off appliance
2. Test Valve V1 and/or Valve V2 for tightness manually.
3. If untight replace Valve V1 and/or Valve V2.

The operation is independent of the test volume and input pressure. In the case of short-term voltage failure during test or burner operation, an automatic restart is performed.

### 3. Operation:

VDK 200 internal valve closes, pump remains off, and "RUN" contact remains energized. Valve 1 and valve 2 are energized by the flame safeguard at an appropriate time.

## Adjustments & Leak Detection Limits

The VDK 200 is factory set for a minimum pipe volume. Depending on the application, the VDK 200 may require an additional adjustment to function properly. This setting is dependent on the area of the Test Volume (volume between the valves). The volume adjustment is located on the outlet side of the VDK 200. (See reference "A" below)

**⚠ Do not adjust or remove any screws or bolts which are sealed with a Red or Blue colored compound. Doing so will void all approvals, warranties and exchange policies.**

The table below lists typical gas volumes determined by pipe size and length.

### Setting Setup

1. After installing the VDK 200 and opening the upstream ball valve, perform an external leak test on the test volume (Volume between the valves) and all gas fittings on the VDK 200. (The VDK 200 can be used to pressurize the Test Volume).

**NOTE: During the setting procedure, the piping upstream of the VDK 200 cannot contain air during calibration. (Only fuel gas should be present).**

- When measuring the pump time, depressurize the test volume by an appropriate tap between the 2 shutoff valves. Close the tap after test volume is fully depressurized.
- When making adjustments, it is recommended to turn the screw "A" in 90° increments.
- To start a valve proving sequence, power the VDK 200 or depress the red reset button.
- Once satisfied with the volume setting, seal the volume adjustment screw with an appropriate compound.

**⚠ In order to prevent functional or leakage problems, we recommend the use of approved, direct acting safety shutoff valves. Do not use diaphragm assisted safety shutoff valves.**

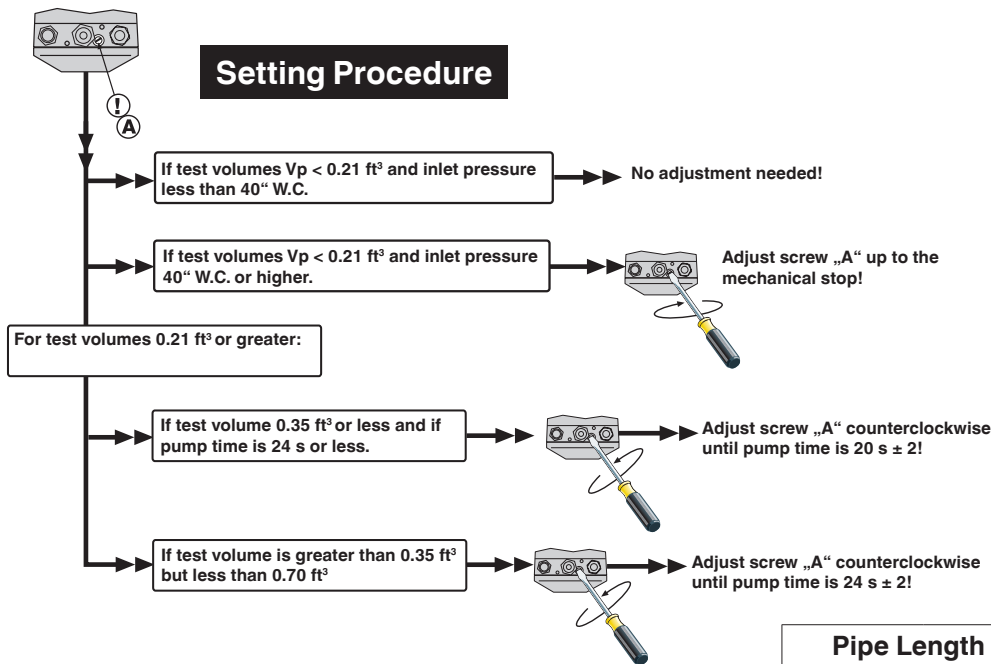

Approx. Leak Detection Limits for each valve Using natural gas and maximum valve proving time				
Inlet Pressure (in. W.C.)	Test Volume (ft <sup>3</sup> )			
	0.010	0.035	0.208	0.347
8	0.25	0.25	0.25	0.25
20	0.50	0.50	0.50	0.50
40	0.70	0.70	0.80	0.70
60 (2.1 PSI)	0.90	0.90	1.00	0.90
80 (2.8 PSI)	1.20	1.20	1.40	1.20
100 (3.6 PSI)	1.60	1.60	1.70	1.60
135 (5 PSI)	1.76	1.76	1.76	1.90

**Leak Detection Limit (ft<sup>3</sup>/hr)**

**NOTE: Detection limit depends on inlet pressure, test volume, gas density, and valve proving time.**

To obtain detectable leakage through both valves, divide the leakage rate above by 1.6.

Pipe Length (ft) between safety valves*				
	1.5	3	4.5	6
3/8"	--	--	--	--
1/2"	--	--	--	0.016
3/4"	--	0.015	0.020	0.025
1"	0.016	0.024	0.033	0.042
1 1/2"	0.047	0.069	0.092	0.115
2"	0.076	0.111	0.146	0.191
2 1/2"	0.128	0.184	0.243	0.299
3"	0.219	0.306	0.392	0.479
4"	0.365	0.500	0.639	--
5"	0.632	--	--	--
6"	--	--	--	--
8"	--	--	--	--

**Estimated Gas Volume (ft<sup>3</sup>)**

**VDK is intended for test volumes between 0.014 to 0.70 ft<sup>3</sup>**  
 -- means out of testing range  
 \* indicates valve sizes for a DUNGS MVD valve. Other valve manufacturers will have different valve volumes

## Maintenance & Testing

The VDK 200 is a protective device. Check it at least annually for proper operation.



**Verify that both automatic shutoff valves are de-energized prior to testing the VDK 200.**

### Test Procedure

1. **With the upstream ball valve opened**, disconnect the 1/4" pipe connection downstream the VDK. Cover the 1/4" pipe connection leading to the downstream side of the VDK using your finger, and then apply a soapy solution to this area. Allow a small gap to form between your finger and the 1/4" connection, and watch for bubbles. Apply more solution if needed. If no bubbles form, the VDK's safety valve is tight. If bubbles form, the leakage rate can then be estimated by connecting a 1/4" flexible hose (having a 45° cut at the end) to the 1/4" connection of the VDK. Obtain a glass of water and immerse the 1/4" tubing about 1/2" below the water line. If the number of bubble exceeds 20 over a 10 second period, replace the VDK.

2. Verify that there is power to the VDK 200 and **that the upstream ball valve is opened**. Then, reset the VDK 200 by pressing the red reset button on top of the black cover. After the VDK 200 stops pumping (approx. 32 s +/- 3 s), the VDK 200 should lock out. Verify this by observing the illuminated red light and by measuring 120 Vac at the ALARM terminal.

**Note:** When the internal pump of the VDK 200 is running, a small amount of gas will flow from the opened tap.

If test procedure 2 fails, immediately remove and replace the VDK 200.



**All connections must be properly tightened and leak tested before any gas is reapplied to the system.**



**Do not try to repair the unit. An attempt to repair the VDK 200 could interfere with its normal operation which may result in a fire or explosion. If the VDK 200 is disassembled, all approvals, warranties, and exchange policies will be void.**

## Trouble Shooting

**#1** VDK alarms, and there are no external leaks or valve seat leakage on either valve.

**#1** On a new installation, the test volume could be too large. Either increase the „volume adjustment“ to accommodate the larger volume, or decrease the test volume. It could also be that the VDK was cycled more than 15 times within 60 minutes, which causes the pump to temporarily weaken, resulting in a lockout (alarm). Allow the pump to cool for 60 minutes, and try again.

If the installation is not new, it could be that the pump has slightly weekend over time. Increase the „volume adjustment“ to accommodate the weakened pump. Or, it could be that the pump is worn out or a part on the printed wiring board failed. If increasing the „volume adjustment“ does not fix the fault, the VDK needs to be replaced.

**#2** VDK indicator light keeps blinking, and there is never an alarm or run signal.

**#2** The printed wiring board is defective.

## Accessories & Replacement

Version	Voltage	Order No.
VDK 200 A S06	120 VAC 60 Hz	253734
VDK 200 A S06 (Brad Harrison™)	120 VAC 60 Hz	267131
Accessory	Voltage	Order No.
Brad Harrison™ Connector		267357



**Karl Dungs, Inc.**  
 3890 Pheasant Ridge Drive NE  
 Suite 150  
 Blaine, MN 55449, U.S.A.  
 Phone 763 582-1700  
 Fax 763 582-1799  
 e-mail [info@karldungsusa.com](mailto:info@karldungsusa.com)  
 Internet <http://www.dungs.com/usa/>

**Karl Dungs GmbH & Co. KG**  
 P.O. Box 12 29  
 D-73602 Schorndorf, Germany  
 Phone +49 (0)7181-804-0  
 Fax +49 (0)7181-804-166  
 e-mail [info@dungs.com](mailto:info@dungs.com)  
 Internet <http://www.dungs.com>