

D**GB****F****I****DUNGS**[®]
Combustion Controls

Konformitäts- erklärung	Declaration of conformity	Déclaration de conformité	Dichiarazione di conformità
Gebrauchs- anleitung	Instructions	Notice d'utilisation	Istruzioni di esercizio e di montaggio
GW...A4 .. HP SGS			
Sondergasaus- führung: Hochdruck- Gas- und Luftdruck- wächter	Special gases version: High pressure gas and air pres- sure switch	Version spéciale gaz: Pressostat haute pression gaz et air	Versione gas speciale: Pressostato di alta pressione per gas e aria



GW...A4 .. HP SGS
256 847



EU-Konformitäts- erklärung

EU Declaration of conformity

Déclaration de conformité UE

Dichiarazione di conformità UE

Produkt / Product Produit / Prodotto	GW...A4 .. HP SGS		Sondergasausführung: Hochdruck- Gas- und Luftdruckwächter Special gases version: High pressure gas and air pressure switch Version spéciale gaz: Pressostat haute pression gaz et air Versione gas speciale: Pressostato di alta pressione per gas e aria
Hersteller / Manufacturer Fabricant / Produttore	Karl Dungs GmbH & Co. KG · Karl-Dungs-Platz 1 · D-73660 Urbach/Germany		
<p>bescheinigt hiermit, dass die in dieser Übersicht genannten Produkte einer EU-Baumusterprüfung (Baumuster) unterzogen wurden und die wesentlichen Sicherheitsanforderungen der:</p> <ul style="list-style-type: none"> • EU-Gasgeräteverordnung (EU) 2016/426 • EU-Druckgeräterichtlinie 2014/68/EU • Niederspannungsrichtlinie 2014/35/EU <p>in der gültigen Fassung erfüllen.</p> <p>Alle nach Druckgeräterichtlinie zugelassenen Komponenten sind Ausrüstungsteile mit Sicherheitsfunktion. Bei einer von uns nicht freigegebenen Änderung des Gerätes verliert diese Erklärung ihre Gültigkeit. Der oben beschriebene Gegenstand der Erklärung entspricht den einschlägigen Harmonisierungsvorschriften der Union. Die alleinige Verantwortung für die Ausstellung dieser Konformitätserklärung trägt der Hersteller.</p>	<p>certifies herewith that the products named in this overview were subjected to an EU-Type Examination (production type) and meet the essential safety requirements:</p> <ul style="list-style-type: none"> • EU-Gas Appliances Regulation (EU) 2016/426 • EU-Pressure Equipment Directive "2014/68/EU" • Low-Voltage Directive "2014/35/EU" <p>as amended.</p> <p>All of the components certified according to the Pressure Equipment Directive are equipment parts with safety function. In the event of an alteration of the equipment not approved by us this declaration loses its validity. The object of the declaration described above conforms with the relevant Union harmonisation legislation. This declaration of conformity is issued under the sole responsibility of the manufacturer.</p>	<p>certifie par la présente que le produit mentionné dans cette vue d'ensemble a été soumis à un examen UE de type (type de fabrication) et qu'il est conforme aux exigences en matières de sécurité des dernières versions en vigueur de :</p> <ul style="list-style-type: none"> • Règlement européen sur les appareils brûlant des combustibles gazeux (UE) 2016/426 • Directive européenne relative aux appareils sous pression 2014/68/UE • Directive basse tension 2014/35/UE <p>Tous les composants homologués conformément à la directive sur les dispositifs sous pression sont des éléments d'équipement à fonction de sécurité. Ce communiqué n'est plus valable si nous effectuons une modification libre de l'appareil. L'objet décrit ci-dessus de la présente déclaration correspond aux prescriptions légales applicables en matière d'harmonisation de l'Union. Le fabricant porte l'entière responsabilité pour l'établissement de la présente déclaration de conformité.</p>	<p>Con la presente si certifica che i prodotti citati in questa panoramica sono stati sottoposti a una prova di esame UE del tipo (tipo di produzione) e che i requisiti di sicurezza essenziali:</p> <ul style="list-style-type: none"> • Regolamento UE sugli apparecchi a gas (UE) 2016/426 • Direttiva UE sulle attrezzature a pressione 2014/68/UE • Direttiva sulla bassa tensione 2014/35/UE <p>sono soddisfatti nella versione valida.</p> <p>Tutti i componenti approvati secondo la direttiva sulle apparecchiature a pressione sono parti di apparecchiature con funzione di sicurezza. In caso di modifica dell'apparecchio non ammessa, questa dichiarazione perde di validità. L'oggetto della dichiarazione di cui sopra descritta è conforme alla pertinente normativa di armonizzazione dell'Unione. La presente dichiarazione di conformità è rilasciata sotto la responsabilità esclusiva del fabbricante.</p>
Prüfgrundlage der EU-Baumusterprüfung (Baumuster) Specified requirements of the EU-Type Examination (production type) Base d'essai de l'examen UE de type (type de fabrication) Criteri di prova dell'omologazione esame UE del tipo (tipo di produzione)	EN 1854 EN 13611 ISO 23550		
Gültigkeitsdauer / Bescheinigung Term of validity / attestation Validité / certificat Durata della validità / Attestazione	2023-07-09 CE0036	2028-02-27 CE-0123CT1089	
Notifizierte Stelle Notified Body Organisme notifié Organismo notificato	2014/68/EU TÜV SÜD Industrie Service GmbH Westendstraße 199 D-80686 München Germany Notified Body number: 0036	(EU) 2016/426 TÜV SÜD Product Service GmbH Zertifizierstellen Ridlerstraße 65 D-80339 München, Germany Notified Body number: 0123	
Überwachung des QS-Systems Monitoring of the QA system Contrôle du système d'assurance qualité Monitoraggio del sistema QS	Gewähltes Konformitätsverfahren Modul B+D Conformity process adopted: Module B+D Procédure de conformité sélectionnée : module B+D Procedura di conformità selezionata: modulo B+D		
B.Sc., MBA Simon P. Dungs, Geschäftsführer / Chief Operating Officer / Directeur / Amministratore Urbach, 2022-08-23			

Declaration of Conformity

Product	GW...A4 .. HP SGS	Special gases version: High pressure gas and air pressure switch	
Manufacturer	Karl Dungs GmbH & Co. KG · Karl-Dungs-Platz 1 · D-73660 Urbach/Germany		
<p>Certifies herewith that the products named in this overview were subjected to a Type Examination (production type) and meet the essential safety requirements:</p> <ul style="list-style-type: none"> • Gas Appliances (Enforcement) and Miscellaneous Amendment Regulations, UKSI 2018:389 (as amended by UKSI 2019:696) • The Pressure Equipment Safety Regulations, UKSI 2016:1105 (as amended by UKSI 2019: 969) • The Electrical Equipment (Safety) Regulations 2016, UKSI 2016: 1101 as amended <p>All of the components certified according to the Pressure Equipment (Safety) Regulations 2016 are equipment parts with safety function. In the event of an alteration of the equipment not approved by us this declaration loses its validity. The object of the declaration described above conforms with the relevant legislation. This declaration of conformity is issued under the sole responsibility of the manufacturer.</p>			
Specified requirements of the Type Examination (production type)	EN 1854 EN 13611		
Term of validity	2032-08-09	2032-08-11	
Approved Bodies	2016 No. 1105 TUV SUD BABT Unlimited Octagon House, Concorde Way, Segensworth North, Fareham, Hampshire, PO15 5RL, United Kingdom Approved Body Number: 0168	2018 No. 389 TUV SUD BABT Unlimited Octagon House, Concorde Way, Segensworth North, Fareham, Hampshire, PO15 5RL, United Kingdom Approved Body Number: 0168	
Monitoring of the QA system	Conformity process adopted: Module B+D		
B.Sc., MBA Simon P. Dungs, Chief Operating Officer Urbach, 2022-08-23			



Betriebs- und Montageanleitung

Sondergasausführung
Hochdruck- Gas- und Luftdruckwächter
GW...A4 .. HP SGS

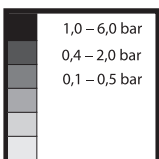
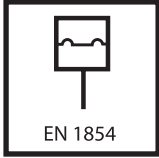

Operation and assembly instructions

Special gas version
High pressure gas and air pressure switch
GW...A4 .. HP SGS

Druckwächter / Pressure Switch/ Pressostat/Pressostato
Typ/Type/Type/Tipo
GW 500 A4 (I/2), GW 2000 A4 (I/2)
nach/acc./selon/a norme EN 1854
GW 6000 A4 (I/2)
nach/acc./selon/a norme DIN 3398T3

TÜV-geprüfte Komponenten für Biogasanlagen gemäß TÜV-Arbeitsanweisung IS-TAF 411.MRZ.-2007. Für Bio- und Klärgase nach DVGW Arbeitsblatt G 262.
TÜV-inspected components for biogas installations according to TÜV work instruction IS-TAF 411.MRZ.-2007. For biogases and sewage gases according to DVGW worksheet G 262.
Composants contrôlés TÜV pour installations à biogaz conformément aux instructions de travail TÜV (IS-TAF 411.MRZ.-2007):
Pour les biogaz et le gaz de curage selon la fiche technique DVGW G 262 Union allemande des techniques de l'eau et du gaz.
Componenti controllati dall'ufficio tedesco per la sorveglianza tecnica TÜV per impianti di biogas in conformità alle istruzioni di lavoro TÜV IS-TAF 411.MRZ.-2007. Per biogas e gas di digestione in conformità al foglio di lavoro dell'associazione tedesca dei settori gas e acqua DVGW G 262.

Einstellbereiche
Setting ranges
Plages de réglage
Campi di taratura

Max. Betriebsdruck / Max. operating pressure/ Pression de service maxi. Max. pressione di esercizio
GW 500 A4 (I/2) HP $p_{max.} = 2 \text{ bar@}0,1-0,15 \text{ bar}$
 $p_{max.} = 5 \text{ bar@}0,15-0,5 \text{ bar}$
GW 2000 A4 (I/2) HP $p_{max.} = 5 \text{ bar}$
GW 6000 A4 (I/2) HP $p_{max.} = 8 \text{ bar}$

Notice d'emploi et de montage

Version spéciale gaz
Pressostat haute pression gaz et air
GW...A4 .. HP SGS

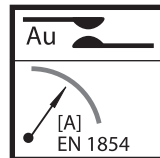
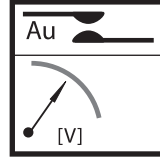

Istruzioni di esercizio e di montaggio

Versione speciale a gas
Pressostato di alta pressione per gas e aria
GW...A4 .. HP SGS

Standard Anwendung/Standard application/Application standard/ Applicazione standard
~(AC) eff./min./mini 24 V,
~(AC) max./maxi. 250 V
=(DC) min./mini. 24 V,
=(DC) max./maxi. 48 V

DDC-Anwendung/DDC application/application DDC/ Applicazione DDC
=(DC) min./mini. 5 V,
=(DC) max./maxi. 24 V

Standard Anwendung/Standard application/Application standard/ Applicazione standard
Nennstrom/nominal current/courant nominal/corrente nominale
~(AC) 10 A
Schaltstrom/current on contact/courant de commutation/corrente di intervento
~(AC) eff./min./mini 20 mA,
~(AC) max./maxi. 6 A $\cos \varphi 1$
~(AC) max./maxi. 3 A $\cos \varphi 0,6$
=(DC) min./mini. 20 mA
=(DC) max./maxi. 1 A

DDC-Anwendung/DDC application/application DDC/ Applicazione DDC
Nennstrom/nominal current/courant nominal/corrente nominale
=(DC) 20 mA
Schaltstrom/current on contact/courant de commutation/corrente di intervento
=(DC) min./mini. 5 mA
=(DC) max./maxi. 20 mA

ACHTUNG / ATTENTION
ATTENTION / ATTENZIONE
Nach Anwendung (> 24V / > 20 mA) ist eine spätere DDC-Anwendung nicht mehr möglich.
After application (> 24V / > 20 mA), a later DDC application is no longer possible.
Après utilisation (> 24 V / > 20 mA), une utilisation DDC ultérieure n'est plus possible.
Consignes d'entretien
Dopo l'impiego (> 24 V / > 20 mA) non è più possibile un impiego DDC.

Schutzart / Degree of protection
Protection / Protezione
GW...A4/2 HP SGS
IP 65 nach / acc. / selon / a norme IEC 529 (EN 60529)



Medium/Medium/Fluide/Fluido vettore

Familie 1 + 2 + 3 (DVGW G 260)
 Bio- und Klärgase (DVGW G 262)
 Sondergase bis max. 1,0 Vol. % H₂S (feucht, + 25 °C) vorbehaltlich anlagenspezifischer Gasanalyse.
 Abgase von Biogasanlagen bis max. 0,1 Vol. % SO₂ (feucht, + 35 °C).
 Nachweislich geeignet für Stall-Atmosphäre in Anlehnung an DIN EN 60730-2-9.
 Flüssigkeiten auf Anfrage.
 Family 1 + 2 + 3 (DVGW G 260)
 Biogases and sewage gases (DVGW G 262)
 Special gases up to a max. of 1.0 % by volume of H₂S (wet, +25 °C) subject to installation-specific gas analysis.
 Flue gases of biogas installations up to a max. of 0.1 % by volume of SO₂ (wet, + 35 °C).
 Proven suitability for barn atmosphere in accordance with DIN EN 60730-2-9.
 Fluids on request
 Famille 1 + 2 + 3 (DVGW G 260)
 Biogaz et gaz de curage (DVGW G 262)
 Gaz particuliers jusqu'à max. 1,0 vol. % H₂S (humide, + 25 °C), sauf l'analyse de gaz spécifique aux installations
 Gaz d'échappement des installations à biogaz jusqu'à 0,1 vol. % SO₂ (humide, + 35 °C).
 Aptitude prouvée pour l'atmosphère dans les écuries selon DIN EN 60730-2-9.
 Liquides sur demande
 Famiglia 1 + 2 + 3 (DVGW G 260)
 Biogas e gas di scarica (DVGW G 262)
 Gas speciali fino a max. 1,0 Vol. % H₂S (umido, + 25 °C) salvo l'analisi del gas specifica dell'impianto.
 Gas di combustione di impianti di biogas fino a max. 0,1 Vol. % SO₂ (umido, + 35 °C).
 Adatto per le condizioni ambientali in stalle in conformità con DIN EN 60730-2-9.
 Fluidi su richiesta

Verkürzung der Gewährleistungsfrist bei Sondergasanwendungen auf 1 Jahr

- Abweichend zu den allgemeinen DUNGS Zahlungs- und Lieferbedingungen wird die Gewährleistungsfrist bei Sondergasanwendungen auf 1 Jahr begrenzt.
- Eine anlagenspezifische Gasanalyse zur Auswahl der Sondergaskomponenten ist deshalb zwingend notwendig.
- Produkte können eine verringerte Lebensdauer haben, wenn die Gasqualität im Betrieb von der durchgeführten Gasanalyse abweicht.

Warranty period for special gas applications reduced to 1 year

- Contrary to the DUNGS General Terms of Payment and Delivery, the warranty period for special gas applications is limited to 1 year.
- This is why an installation-specific gas analysis for selecting the special gas component is absolutely required.
- Products may have a shorter service life if the gas quality during operation differs from the gas analysis that was carried out.

Limitation du délai de garantie à un an pour les applications gaz particuliers

- Contrairement aux conditions générales de paiement et de livraison DUNGS, le délai de garantie pour les applications gaz particuliers est limité à un an.
- C'est pourquoi une analyse de gaz spécifique aux installations permettant de sélectionner les composants du gaz particulier est obligatoire.
- Des produits peuvent avoir une durée de vie réduite si la qualité du gaz lors de l'utilisation diffère de l'analyse de gaz effectuée.

Riduzione del termine di garanzia a 1 anno in caso di impiego di gas speciali

- A differenza delle condizioni generali di pagamento e consegna della DUNGS, il termine di garanzia viene ridotto a 1 anno in caso di impiego di gas speciali.
- Un'analisi del gas specifica dell'impianto è imprescindibile per la scelta dei componenti per gas speciali.
- I prodotti possono avere una durata utile ridotta se la qualità del gas diverge durante il funzionamento dall'analisi del gas eseguita.

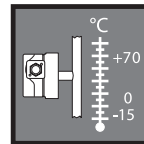

Umgebungstemperatur
 Ambient temperature
 Température ambiante
 Temperatura ambiente
 -15 °C ... +70 °C

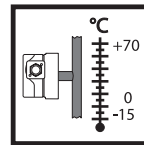

Mediumstemperatur
 Medium temperature
 Température du fluide
 Temperatura fluido
 -15 °C ... +70 °C

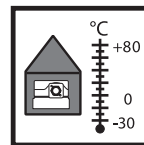

Lagertemperatur
 Storage temperature
 Température de stockage
 Temperatura stoccaggio
 -30 °C ... +80 °C

Einbaulage / Installation position / Position de montage / Posizione de montaggio



Standard einbaulage; bei Abweichung Schaltpunktänderung beachten:
 Standard installation position; in case of deviation, take the switch point change into account:
 Position de montage standard ; en cas de divergence, veiller à la modification du point de commutation.
 Posizione di montaggio standard, per altre posizioni di montaggio osservare il cambiamento del punto di intervento:
 GW 500 A4 ca. ± 0,010 bar
 GW 2000 A4 ca. ± 0,020 bar
 GW 6000 A4 ca. ± 0,080 bar

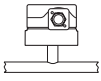

Bei waagerechtem Einbau schaltet der Druckwächter bei einem höheren Druck.
 When installed horizontally, the pressure switch responds if the pressure is higher.
 En position horizontale, le pressostat réagit à une pression supérieure.
 Con montaggio orizzontale il pressostato scatta ad un aumento di pressione.

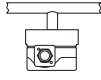

Bei Einbau waagrecht über Kopf schaltet der Druckwächter bei einem niedrigeren Druck.
 When installed horizontally in an upside down position, the pressure switch responds if the pressure is lower.
 En position horizontale à l'envers, le pressostat réagit à une pression inférieure.
 Con montaggio orizzontale capovolto il pressostato scatta ad una diminuzione di pressione.

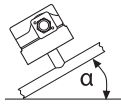

Bei Einbau in einer Zwischeneinbaulage schaltet der Druckwächter bei einem vom eingestellten Sollwert maximal höheren bzw. niedrigeren Druck.
 When installed at an intermediate position, the pressure switch responds if there is maximum upper or lower pressure deviation w.r.t. the set pressure reference value.
 En position de montage intermédiaire, le pressostat réagit à une pression maximale supérieure ou inférieure à la valeur de consigne réglée.
 Con montaggio in una posizione intermedia il pressostato scatta ad una pressione diversa da quella nominale massima regolata.

Einbaumaße/Dimensions

Cotes d'encombrement/Dimensioni [mm] GW...A4 HP

ø 2,5 x 9 tief für Gerätestecker DIN EN 175 301-803
 2.5 x 9 dia. deep for DIN EN 175 301-803 equipment plug
 ø 2,5 x 9 de profond pour embase de connecteur DIN EN 175 301-803
 profondo per spina ø 2,5 x 9 DIN EN 175 301-803

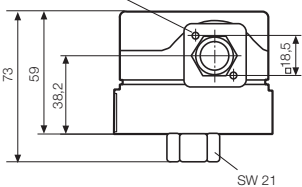

Druckanschluß G 1/4, Rp 1/4
 Gas oder Luft
 G 1/4 pressure connection
 gas or air
 Raccord de pression G 1/4, Rp 1/4
 gaz ou air
 Attacco pressione G 1/4, Rp 1/4
 gas oppure aria



M20 x 1,5 oder Steckanschluß für Leitungsdose
 nach DIN EN 175 301-803
 M20 x 1,5 or plug-type connection for cable
 socket according to DIN EN 175 301-803
 M20 x 1,5 ou fiche pour boîtier suivant
 DIN EN 175 301-803
 M20 x 1,5 oppure collegamento a spina per
 presa di rete a norme DIN EN 175 301-803

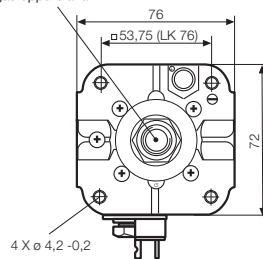

4 X ø 4,2 -0,2

Einbaumaße/Dimensions

Cotes d'encombrement/Dimensioni [mm] GW...A4/2 HP

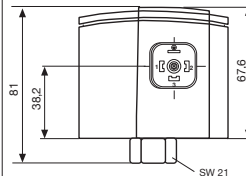

4 selbstturchende Zylinderschrauben M3x14
 Längsschlit 0,8 und Kreuzschlit DIN 7962-Z2
 4 self-tapping cylinder bolts M3x14 slot 0.8
 and cross slot to DIN 7962-Z2
 4 vis auto-taradeuses tête cylindrique M3x14 tête fendue 0,8
 et empreinte cruciforme DIN 7962-Z2
 Quattro viti a testa cilindrica autofilettanti M3x14
 intaglio longitudinale 0,8 e intaglio a croce DIN 7962-Z2



SW = Schlüsselweite
 SW = Wrench width
 SW = Ouverture de clé
 SW = Apertura chiave

M20 x 1,5 oder Steckanschluß für
 Leitungsdose nach DIN EN 175 301-803
 M20 x 1,5 or plug-type connection for cable
 socket according to DIN EN 175 301-803
 M20 x 1,5 ou fiche pour Boîtier suivant
 DIN EN 175 301-803
 M20 x 1,5 oppure collegamento a spina
 per presa di rete a norme DIN EN 175 301-803

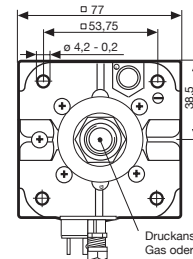

Druckanschluß G 1/4, Rp 1/4
 Gas oder Luft
 G 1/4 pressure connection
 gas or air
 Raccord de pression G 1/4, Rp 1/4
 gaz ou air
 Attacco pressione G 1/4, Rp 1/4
 gas oppure aria

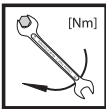

max. Drehmomente / Systemzubehör
 max. torque / System accessories
 max. couple / Accessoires du système
 max. coppie / Accessorio di sistema

M 3 M 4 G 1/4

1,2 Nm 2,5 Nm 7 Nm



Geeignetes Werkzeug einsetzen!
Please use proper tools!
Utiliser des outils adaptés!
Impiegare gli attrezzi adeguati!



Gerät darf nicht als Hebel benutzt werden
Do not use unit as lever.
Ne pas utiliser le pressostat comme un levier.
L'apparecchio non deve essere usato come leva.

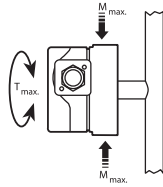

DN	8
Rp	1/4
<hr/>	
M _{max.}	35 [Nm] t ≤ 10 s
<hr/>	
T _{max.}	20 [Nm] t ≤ 10 s

Einbau
 GW...A4, GW...A4/2

1. Der Druckwächter wird direkt auf einen Rohrstützen mit R 1/4 Außengewinde aufgeschraubt. Bild 1.
2. Nach Einbau Dichtheits- und Funktionskontrolle durchführen.

Installation of
 GW...A4, GW...A4/2

1. Screw the pressure switch directly on a tube socket with R 1/4 outer thread (see Fig. 1).
2. After installation, perform a leakage and function test.

Montage
 GW...A4, GW...A4/2

1. Le pressostat peut se visser directement sur un piquage R 1/4" Fig.1.
2. Après le montage contrôler la fonction et l'étanchéité.

Installazione
 GW...A4, GW...A4/2

1. Il pressostato viene avvitato direttamente su un tubo di sostegno con filetto esterno R 1/4 (Fig.1)
2. Dopo il montaggio effettuare i controlli di tenuta e funzionalità.

Auf vibrationsfreien Einbau achten! Bild 2.

Ensure that the pressure switch is installed free of vibration! (see Fig. 2).

Veiller à ce que l'appareil ne subisse pas de vibrations! Fig. 2.

Evitare possibilità di vibrazioni! Fig 2.

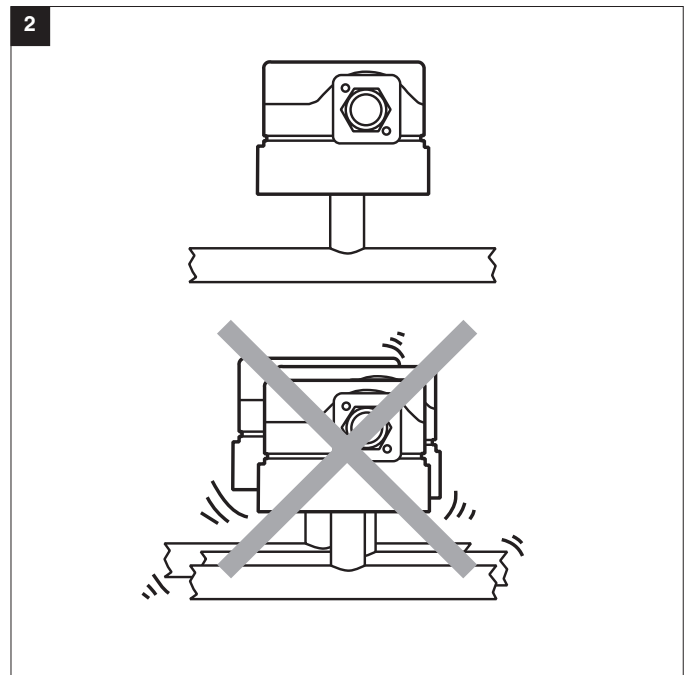
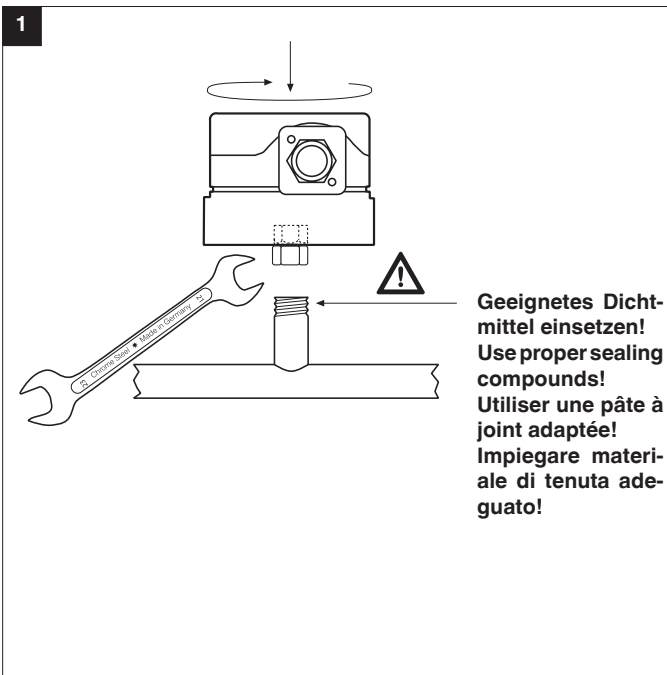

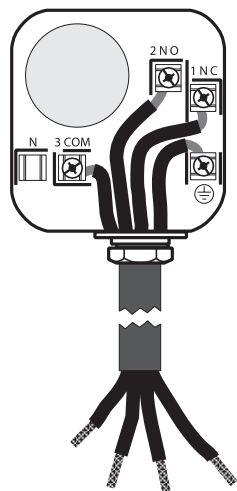

Elektrischer Anschluß
Electrical connection
Raccordamento elettrico
Allacciamento elettrico
IEC 730-1 (VDE 0631 T1)

GW ... A4 M20x1,5
 GW ... A4/2 M20x1,5

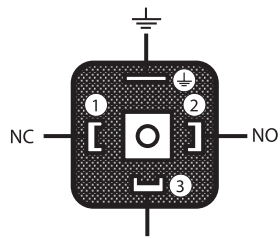

DIN EN 175 301-803



 Erdung nach örtlichen Vorschriften.
 Grounding acc. local regulations.
 Mise à la terre selon normes locales.
 Messa a terra secondo prescrizioni locali.

Zur Erhöhung der Schaltleistung wird bei DC-Anwendungen < 20 mA und 24 V der Einsatz eines RC-Gliedes empfohlen.

To increase the switching capacity, we recommend that you use a RC device for current values < 20 mA and 24 V d.c. applications.

Pour augmenter la puissance de rupture, l'utilisation d'un circuit RC est préconisée pour les applications à courant continu < 20 mA et 24 V.

Per aumentare la potenza d'inserimento con applicazioni DC < 20 mA e 24 V, consigliamo l'impiego di un elemento RC.

Schaltfunktion
Switching function
Schéma électrique
Funzione di commutazione
pressostato
GW...A4, GW...A4/2

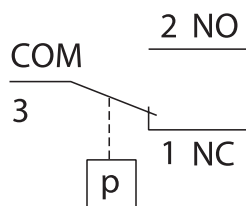

Bei steigendem Druck:
 1 NC öffnet, 2 NO schließt.
Bei fallendem Druck:
 1 NC schließt, 2 NO öffnet.

While pressure is increasing:
 1 NC opens, 2 NO closes.
While pressure is decreasing:
 1 NC closes, 2 NO opens.

Pression montante:
 1 NC ouvre, 2 NO ferme.
Pression descendante:
 1 NC ferme, 2 NO ouvre

Con pressione in salita:
 1 NC apre, 2 NO chiude.
Con pressione in discesa:
 1 NC chiude, 2 NO apre

Einstellung des Druckwächters
Haube mit geeignetem Werkzeug demontieren, Schraubendreher No. 3 bzw. PZ 2, Bild 1. Haube abnehmen.

⚠ Berührungsschutz ist nicht grundsätzlich gewährt, Kontakt mit spannungsführenden Teilen möglich.

Druckwächter am Einstellrad mit Skala **I** auf vorgeschriebenen Drucksollwert einstellen, Bild 2.

Anleitung des Brennerherstellers beachten!

Druckwächter schaltet bei steigendem Druck: Einstellung **↑**.
Druckwächter schaltet bei fallendem Druck: Einstellung **↓**.
Haube wieder aufsetzen!

Setting the pressure switch

Dismount the hood using a suitable tool, e.g. screwdriver no. 3 or PZ2, Fig. 1. Remove hood.

⚠ There is no protection against accidental contact. Contact with live parts is possible.

Set the pressure switch at the setting wheel **I** to the specified pressure setpoint using the scale, Fig. 2.

Follow the instructions of the burner manufacturer!

Pressure switch switches as pressure increases: Setting **↑**.
Pressure switch switches as pressure reduces: Setting **↓**.
Remount hood!

Réglage des pressostats

Enlever les vis du capot en utilisant un tournevis N°3. ou PZ 2, Fig 1. Enlever le capot.

⚠ La protection n'est pas garantie, contact avec des pièces sous tension possible.

Régler le pressostat avec son bouton gradué **I** à la valeur désirée, Fig. 2.

Respecter les recommandations du constructeur du brûleur!

Le pressostat commute par pression montante: Réglage **↑**.
Le pressostat commute par pression descendante: Réglage **↓**.
Remonter le capot!

Regolazione del pressostato

Smontare la calotta con un attrezzo adeguato, ossia cacciavite nr. 3, PZ 2, figura 1 Togliere la calotta.

⚠ Non é sostanzialmente garantita la protezione da scariche, é possibile il contatto con conduttori di tensione.

Tarare il pressostato, come in figura 2, sul valore di pressione nominale prescritto, agendo sulla rotella della scala graduata **I**.

Prestare attenzione alle prescrizioni del produttore del bruciatore!

Il pressostato scatta con pressione in salita: Regolazione **↑**. Il pressostato scatta con pressione in discesa: Regolazione **↓**. Rimontare la calotta!

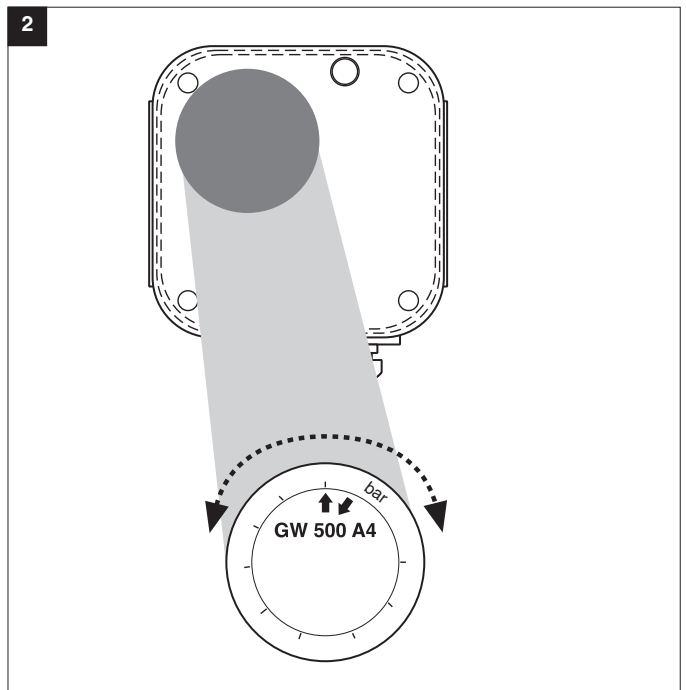
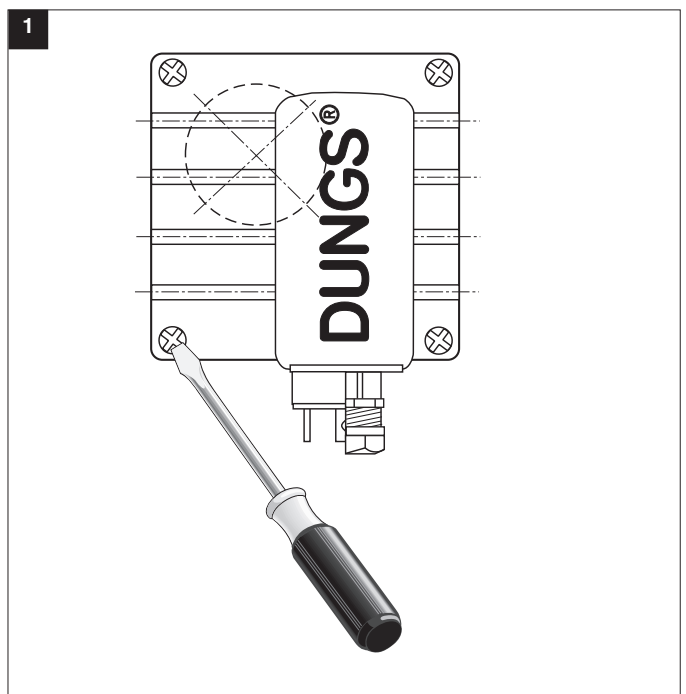

Ersatzteile / Zubehör Spare parts / Accessories Pièces de rechange / access. Parti di ricambio / Accessori	Bestell-Nummer Ordering No. No. de commande Codice articolo
Set: Gerätestecker G3, 3-pol + E für GW...A4 Kit: G3 equipment plug, 3-pin + E for GW...A4 Kit: Connecteur d'appareil G3, 3 pôles + E pour GW...A4 Set composto da: Spina G3 a 3 poli + terra	219 659
Leitungsdosen 3-pol + E, grau GDMW für GW...A4, A4/2 Line sockets, 3-pin + E grey GDMW for GW...A4, A4/2 Prises 3 pôles + T, gris GDMW pour GW...A4, A4/2 Presa a 3 poli + terra, grigia GDMW a GW...A4, A4/2	210 318

Ersatzteile / Zubehör Spare parts / Accessories Pièces de rechange / access. Parti di ricambio / Accessori	Bestell-Nummer Ordering No. No. de commande Codice articolo						
Montage-Set Glimmlampen Neon glow lamp assembly set Lampes fluorescentes, kit de montage Set die montaggio lampadina a bagliore grün/green/verte/verde	<table border="1"> <tr> <td>230 V</td> <td>24 V</td> </tr> <tr> <td>248 239</td> <td>248 240</td> </tr> </table>	230 V	24 V	248 239	248 240		
230 V	24 V						
248 239	248 240						
Montage-Set Glimmlampen Neon glow lamp assembly set Lampes fluorescentes, kit de montage Set die montaggio lampadina a bagliore gelb/yellow/jaune/giallo	<table border="1"> <tr> <td>230 V</td> <td>120 V</td> <td>24 V</td> </tr> <tr> <td>231 773</td> <td>231 772</td> <td>231 774</td> </tr> </table>	230 V	120 V	24 V	231 773	231 772	231 774
230 V	120 V	24 V					
231 773	231 772	231 774					



Arbeiten am Druckwächter dürfen nur von Fachpersonal durchgeführt werden.

Work on the pressure switch may only be performed by specialist staff.

Seul du personnel spécialisé peut effectuer des travaux sur le pressostat.

Qualsiasi operazione effettuata sul pressostato deve essere fatta da parte di personale competente.



Kondensat darf nicht in das Gerät gelangen. Bei Minustemperaturen, durch Vereisung Fehlfunktion/Ausfall möglich.

Do not allow condensate to flow into the equipment. In case of sub-zero temperatures, malfunction or equipment failure may be possible due to icing.

Eviter l'entrée de condensats dans le pressostat, une prise en glace par température négative nuirait à son fonctionnement.

Nell'apparecchio non deve infiltrarsi alcuna condensa. Alle temperature negative sarebbero possibili disfunzioni dovute a formazione di ghiaccio.

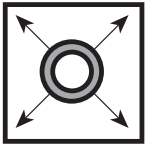

Rohrleitungsdichtheitsprüfung: Kugelhahn vor dem Druckwächter schließen.

Pipeline leakage test: close ball valve upstream of the pressure switch.

Contrôle de l'étanchéité de la conduite: fermer le robinet à boisseau sphérique avant le pressostat.

Per la prova di tenuta delle tubature: chiudere il rubinetto a sfera davanti al corpo pressostato.



Nach Abschluß von Arbeiten am Druckwächter: Dichtheitskontrolle und Funktionskontrolle durchführen.

On completion of work on the pressure switch, perform a leakage and function test.

Une fois les travaux sur le pressostat terminés, procéder toujours à un contrôle d'étanchéité et de fonctionnement.

Al termine dei lavori effettuati su un pressostato: predisporre un controllo sia della tenuta che del funzionamento.



Niemals Arbeiten durchführen, wenn Gasdruck oder Spannung anliegt. Offenes Feuer vermeiden. Örtliche Vorschriften beachten.

Never perform work if gas pressure or power is applied. No naked flame. Observe local regulations.

Ne jamais effectuer des travaux sous pression et sous tension. Eviter toute flamme ouverte. Observer les réglementations.

In nessun caso si debbono effettuare lavori in presenza di pressione gas o di tensione elettrica. Evitare i fuochi aperti e osservare le prescrizioni di sicurezza locali.



Bei Nichtbeachtung der Hinweise sind Personen- oder Sachfolgeschäden denkbar.

If these instructions are not heeded, the result may be personal injury or damage to property.

En cas de non-respect de ces instructions, des dommages corporels ou matériels sont possible.

La non osservanza di quanto suddetto può implicare danni a persone o cose.



Alle Einstellungen und Einstellwerte nur in Übereinstimmung mit der Betriebsanleitung des Kessel-/Brennerherstellers ausführen.

Any adjustment and application-specific adjustment values must be made in accordance with the appliance-/boiler manufacturers instructions.

Effectuer tous les réglages et réaliser les valeurs de réglage uniquement selon le mode d'emploi du fabricant de chaudières et de brûleurs.

Realizzare tutte le impostazioni e i valori impostati solo in conformità alle istruzioni per l'uso del costruttore della caldaia/ del bruciatore.



Silikonöle und flüchtige Silikonbestandteile (Siloxane) in der Umgebung vermeiden. Fehlfunktion / Ausfall möglich.

Avoid silicone oils and volatile silicones (siloxanes) in the environment. Malfunction/failure possible.

Eviter les huiles de silicone et les éléments de silicone volatils (siloxanes) dans l'environnement. Dysfonctionnement / panne possibles.

Evitare oli silicnici e componenti silicnici volatili (silossani) nell'ambiente. Possibile disfunzione / guasto.



Sicherheitsrelevante Komponenten sind gemäß der Landwirtschaftlichen Berufsgenossenschaft / Deutschland, technische Information Nr. 4, wöchentlich auf Funktion und Dichtheit zu prüfen und bei Ausfall sofort, spätestens nach Erreichen ihrer Nutzungsdauer auszutauschen.

Safety-relevant components must be checked, according to the German Agricultural Institution for Statutory Accident Insurance and Prevention, Technical Information No. 4, once a week for functioning and tightness and, in the event of breakdown, replaced immediately, but no later than after reaching the end of their service life.

Le fonctionnement et l'étanchéité des composants de sécurité doivent être contrôlés chaque semaine conformément aux informations techniques n° 4 de l'association des professionnels de l'agriculture en Allemagne et, en cas de panne, être remplacés immédiatement, toutefois au plus tard dès que la durée d'utilisation est atteinte.

In conformità con l'associazione tedesca di categoria agricola, informazione tecnica n. 4 è necessario eseguire ogni settimana una prova di funzionamento e di tenuta sui componenti rilevanti per la sicurezza e sostituirli immediatamente in caso di guasto o al più tardi una volta decorsa la loro durata utile di esercizio.

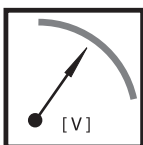
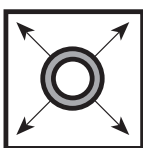

Funktionsprüfung

einmal pro Woche und nach Betriebsstörung

Checks

Once a week and after malfunctions

Contrôles

une fois par semaine et après des pannes

Controlli

Una volta a settimana e dopo anomalie di funzionamento

a) Dichtheitsprüfung

a) Tightness test

a) Contrôle d'étanchéité

a) Prova di tenuta

Die Armaturenteile im Betrieb mit geeignetem Leck-spray auf Dichtheit prüfen.

The fittings must be checked for tightness during operation by spraying them with a suitable leak finder.

Vérifier à l'aide d'un aérosol de contrôle des fuites approprié si les robinets sont étanches durant le fonctionnement.

Eseguire una prova di tenuta durante il funzionamento spruzzando dell'agente rivelatore di fughe sui componenti delle armature.

b) Schaltpunktprüfung

b) Switching point test

b) Contrôle du point de commutation

b) Controllo del punto di commutazione

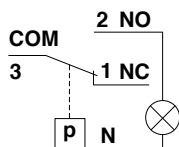

Bei steigendem Druck:
1 NC öffnet,
2 NO schließt.
Glimmlampe leuchtet oder Voltmeter benutzen.

While pressure is increasing:
1 NC opens
2 NO closes
Incandescent lamp is lit or voltmeter should be used.

Pression montante:
1 NC ouvre
2 NO ferme
La lampe lumineuse s'allume ou utiliser un voltmètre.

Con pressione in salita:
1 NC apre
2 NO chiude
La lampada fluorescente è illuminata o utilizzare il voltmetro.

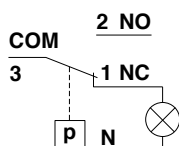

Bei fallendem Druck:
1 NC schließt,
2 NO öffnet
Glimmlampe leuchtet oder Voltmeter benutzen.

While pressure is decreasing:
1 NO opens
2 NC closes
Incandescent lamp is lit or voltmeter should be used.

Pression descendante:
2 NO ouvre
1 NC ferme
La lampe lumineuse s'allume ou utiliser un voltmètre.

Con pressione in discesa:
2 NO apre
1 NC chiude.
La lampada fluorescente è illuminata o utilizzare il voltmetro.



Die Druckgeräterichtlinie (PED) und die Richtlinie über die Gesamtenergieeffizienz von Gebäuden (EPBD) fordern eine regelmäßige Überprüfung der Wärmeerzeuger zur langfristigen Sicherstellung von hohen Nutzungsgraden und somit geringster Umweltbelastung.

Es besteht die Notwendigkeit sicherheitsrelevante Komponenten nach Erreichen ihrer Nutzungsdauer auszutauschen:

The Pressure Equipment Directive (PED) and the Energy Performance of Buildings Directive (EPBD) require a periodic inspection of heat generators in order to ensure a high degree of efficiency over a long term and, consequently, the least environmental pollution.

It is necessary to replace safety-relevant components after they have reached the end of their useful life:

La directive équipements sous pression (PED) et la directive sur la performance énergétique des bâtiments (EPBD) exigent une vérification régulière des générateurs de chaleur afin de garantir à long terme des taux d'utilisation élevés et par conséquent une charge environnementale minimum.

Il est nécessaire de remplacer les composants relatifs à la sécurité lorsqu'ils ont atteint la fin de leur vie utile :

La direttiva per apparecchi a pressione (PED) e la direttiva per l'efficienza dell'energia totale per edifici (EPBD), esigono il controllo regolare dei generatori di calore per la garanzia a lungo termine di un alto grado di rendimento e quindi di basso inquinamento ambientale.

Ciò rende necessaria la sostituzione di componenti rilevanti dal punto di vista della sicurezza alla scadenza della loro durata di utilizzazione:

Sicherheitsrelevante Komponente Safety-relevant component Composant relatif à la sécurité Componenti rilevanti per la sicurezza	Konstruktionsbedingte Lebensdauer Design-related service life Durée de vie prévue Durata di vita di progetto		Norm Standard Norme Norma	Dauerhafte Lagertemperatur Permanent storage temperature Température de stockage permanente Temperatura di stoccaggio permanente
	Zyklenzahl Operating cycles Cycle d'opération Numero di cicli di funzionamento	Jahre Years Années Anni		
Ventilprüfsysteme / Valve testing systems / Systèmes de contrôle de vanne / Sistemi di controllo valvole	250 000	10	EN 1643	0...45 °C 32...113 °F
Gas / Gas / Gaz / Gas Druckwächter / Pressure switch / Manostat / Pressostato	50 000	10	EN 1854	
Luft / Air / Air / Aria Druckwächter / Pressure switch / Manostat / Pressostato	250 000	10	EN 1854	
Gas mangelschalter / Low gas pressure switch / Pressostat gaz basse pression / Pressostato gas di minima pressione	N/A	10	EN 1854	
Feuerungsmanager / Automatic burner control / Dispositif de gestion de chauffage / Gestione bruciatore	250 000	10	EN 298 EN 230	
UV-Flammenfühler ¹ UV flame sensor ¹ Capteur de flammes UV ¹ Sensore fiamma UV ¹	N/A	10 000 h ³	---	
Gasdruckregelgeräte ¹ Gas pressure regulators ¹ Dispositifs de réglage de pression du gaz ¹ Regolatori della pressione del gas ¹	N/A	15	EN 88-1 EN 88-2	
Gasventil mit Ventilprüfsystem ² Gas valve with valve testing system ² Vanne de gaz avec système de contrôle de vanne ² Valvola del gas con sistema di controllo valvola ²	nach erkanntem Fehler after error detection après détection d'erreur dopo segnalazione di errore		EN 1643	
Gasventil ohne Ventilprüfsystem ² Gas valve without valve testing system ² Vanne de gaz sans système de contrôle de vanne ² Valvola del gas senza sistema di controllo valvola ²	DN ≤ 25 200 000 25 < DN ≤ 80 100 000 80 < DN ≤ 150 50 000	10	EN 161	
Gas-Luft-Verbundsysteme / Gas-air ratio control system / Systèmes combinés gaz/air / Sistemi di miscelazione gas-aria	N/A	10	EN 88-1 EN 12067-2	

¹ Nachlassende Betriebseigenschaften wegen Alterung / Performance decrease due to ageing /
Réduction de performance due au vieillissement / Riduzione delle prestazioni dovuta all'invecchiamento

² Gasfamilien II, III / Gas families II, III / Familles de gaz II, III / per i gas delle famiglie II, III

³ Betriebsstunden / Operating hours / Heures de service / Ore di esercizio

N/A nicht anwendbar / not applicable / non applicable / non applicabile

Lagerzeiten / Storage times / Périodes de stockage / Tempi di stoccaggio

Lagerzeiten ≤ 1 Jahr verkürzen nicht die konstruktionsbedingte Lebensdauer.

Storage time ≤ 1 year does not reduce the design-related service life.

Les périodes de stockage ≤ 1 an ne réduisent pas la durée de vie liée à la conception.

I tempi di stoccaggio ≤ 1 anno non riducono la durata di vita di progetto.

DUNGS empfiehlt eine maximale Lagerzeit von 3 Jahren.

DUNGS recommends a maximum storage time of 3 years.

DUNGS recommande une durée de stockage maximale de 3 ans.

DUNGS raccomanda un tempo massimo di stoccaggio di 3 anni.

Änderungen, die dem technischen Fortschritt dienen, vorbehalten / We reserve the right to make modifications in the course of technical development.
Sous réserve de tout modification constituant un progrès technique / Ci riserviamo qualsiasi modifica tecnica e costruttiva

Hausadresse
Head Offices and Factory
Usine et Services Administratifs
Amministrazione e Stabilimento

Karl Dungs GmbH & Co. KG
Karl-Dungs-Platz 1
D-73660 Urbach, Germany
Telefon +49 7181-804-0
Telefax +49 7181-804-166

Briefadresse
Postal address
Adresse postale
Indirizzare la corrispondenza a

Karl Dungs GmbH & Co. KG
Postfach 12 29
D-73602 Schorndorf
e-mail info@dungs.com
Internet www.dungs.com